

SECTION 11 53 01
LABORATORY EQUIPMENT: EVA362329AXA Vented Enclosures
CSI (Construction Specifications Institute) Standard Format

PART 1 GENERAL

1.1 SECTION INCLUDES

- A. Laboratory equipment: Top Mount Vented Equipment Enclosure EVA362329AXA
- B. General Description: A 35.75" wide (Exterior Dimension) by 22.75" deep (exterior dimension) by 28.88" High (Interior dimension) containment device including an exterior fan provided by the containment unit manufacturer. Device plenum shall terminate at its top with a 3.9" exhaust duct and a vent adapter kit. Unit features include stable air flow, low vibration characteristics facilitating highly accurate weighing, and turbulence-free airflow with demonstrably cross-contamination free characteristics.

1.2 RELATED SECTIONS

- A. Section 12 31 00 Laboratory Furniture
- B. Section 23 230 130 Exhaust and HVAC Equipment

1.3 REFERENCES

- A. ASTM E 84 - Standard Test Method for Surface Burning Characteristics of Building Materials.
- B. ASHRAE 110-2016
- C. SEFA 1 2010
- D. NFPA 30 2015
- E. NFPA 45 2015
- F. UL 1805
- G. UL 61010-1

1.4 SUBMITTALS

- A. Submit under provisions of Section 01 30 00 - Administrative Requirements.
- B. Product Data: Manufacturer's data sheets on each product to be used, including:
 - 1. Preparation instructions and recommendations.
 - 2. Storage and handling requirements and recommendations.
 - 3. Installation methods.
- C. Shop Drawings: provide schematics of mechanical and electrical connections.

1.5 QUALITY ASSURANCE

- A. Manufacturer Qualifications: Minimum 3 years experience manufacturing similar products.
- B. Installer Qualifications: Minimum 5 years experience installing similar products.
- C. Provide an ASHRAE 110-2016 containment test which demonstrates a containment of 0.050 PPM or better and laminar face velocity,

1.6 PRE-INSTALLATION MEETINGS

Convene minimum two weeks prior to starting work of this section.

1.7 DELIVERY, STORAGE, AND HANDLING

- A. Deliver and store products in manufacturer's unopened packaging bearing the brand name and manufacturer's identification until ready for installation.
- B. Handling: Handle materials to avoid damage.

1.8 PROJECT CONDITIONS

Maintain environmental conditions (temperature, humidity, and ventilation) within limits recommended by manufacturer for optimum results. Do not install products under environmental conditions outside manufacturer's recommended limits.

1.9 SEQUENCING

- A. Ensure that products of this section are supplied to affected trades in time to prevent interruption of construction progress.
- B. WARRANTY: Top Mount Vented Balance Enclosure: 1 year Limited Warranty

Warranty: Manufacturer's warranty shall not apply to any product or part thereof which has been subject to misuse, abuse, accident, shipping damage, improper installation or service, or damage by fire, flood or acts of God. If the serial number of this product is altered, removed or defaced as to be illegible, the warranty shall be null and void in its entirety.

PART 2 GENERAL PRODUCT REQUIREMENTS

2.1 MANUFACTURERS

- A. Acceptable Manufacturer shall be Flow Sciences Inc. which is located at 2025 Mercantile St., Leland NC 28451; substitutions shall not be permitted unless condition C is met and approved by the customer.
- B. Manufacturer shall be ISO 9001 Certified; substitutions shall not be permitted unless condition C is met and approved by the customer.
- C. Requests for substitutions will be considered in accordance with provisions of Section 01 60 00 - Product Requirements.

2.2 Vented Equipment Enclosure EVA362329AXA **Material and Performance Specifications:**

- A. Unit shall have these **dimensions**: 35.75" (exterior) W X 22.75" D (exterior) X 28.88"H (Interior) .
- B. Transparent 0.375" clear **Acrylic front, side panels with transparent curved airfoil.**
- C. White 0.375" **polypropylenes baffle**, back, and top panels.
- D. Hinged, angled front door to facilitate equipment insertion.
- E. Unit is **all welded construction.**
- F. Top mounted 3.9" exhaust duct collar and vent attachment kit.
- G. Unit is **all welded construction.**
- H. Separate fan-HEPA filter unit shall be fabricated from 18ga. sheet metal, painted white.
- I. Fan / Filter Housing Performance Data shall be:
 - 1) Volts 110-120 AC
 - 2) Amps = 2.4
 - 3) Watts = 290
 - 4) Max CFM limit fan/filter =240
 - 5) Overall fan sound output of 50-55 dB @ 3 feet. .
 - 6) Fan speed control unit included to properly set flow rate
 - 7) HEPA exhaust filter and fan unit shall be located in a bench-mounted 14.5" Square by 20.86 " high **balanced** and **vibration isolated** fan housing. Housing shall contain one pleated high-efficiency HEPA filter for low static pressure resistance and improved fan performance during filter loading.
- J. 0.50" Black Phenolic Resin base with routed and sealed attachment to containment structure sides and walls shall be provided.
- K. Velocity Alarm 110-120 VAC, single phase, 0.2 Amps with dry contact optional shall be provided. Alarm shall be equipped with red light which warns of low velocity and green light which indicates nominal containment velocity.
- L. Alarm works can be custom mounted where convenient. Alarm sensor pre-mounted with pre-wired pigtail.

2.3 Factory Testing of Hood Shall Include:

- A. ASHRAE 110-2016 containment of ≤ 0.050 PPM
- B. Human as Mannequin Test of ≤ 0.050 PPM
- C. Any powder containment test selected by customer may be run on the manufactured unit at the customer's request as a separate option.
- D. Copies of all specified test shall be delivered to the customer's designated representative at the time of product shipment.

PART 3 EXECUTION

3.1 EXAMINATION

- A. Do not begin installation until substrates have been properly prepared.
- B. If substrate preparation is the responsibility of another installer, notify Architect of unsatisfactory preparation before proceeding.

3.2 INSTALLATION

- A. Clean surfaces thoroughly prior to installation.
- B. Install in accordance with manufacturer's instructions. Test for proper operation and adjust until proper operation is achieved.

3.3 PROTECTION

- A. Protect installed products until completion of project.
- B. Touch-up, repair or replace damaged products before Substantial Completion.

EVA362329AXA Dimension Summary:

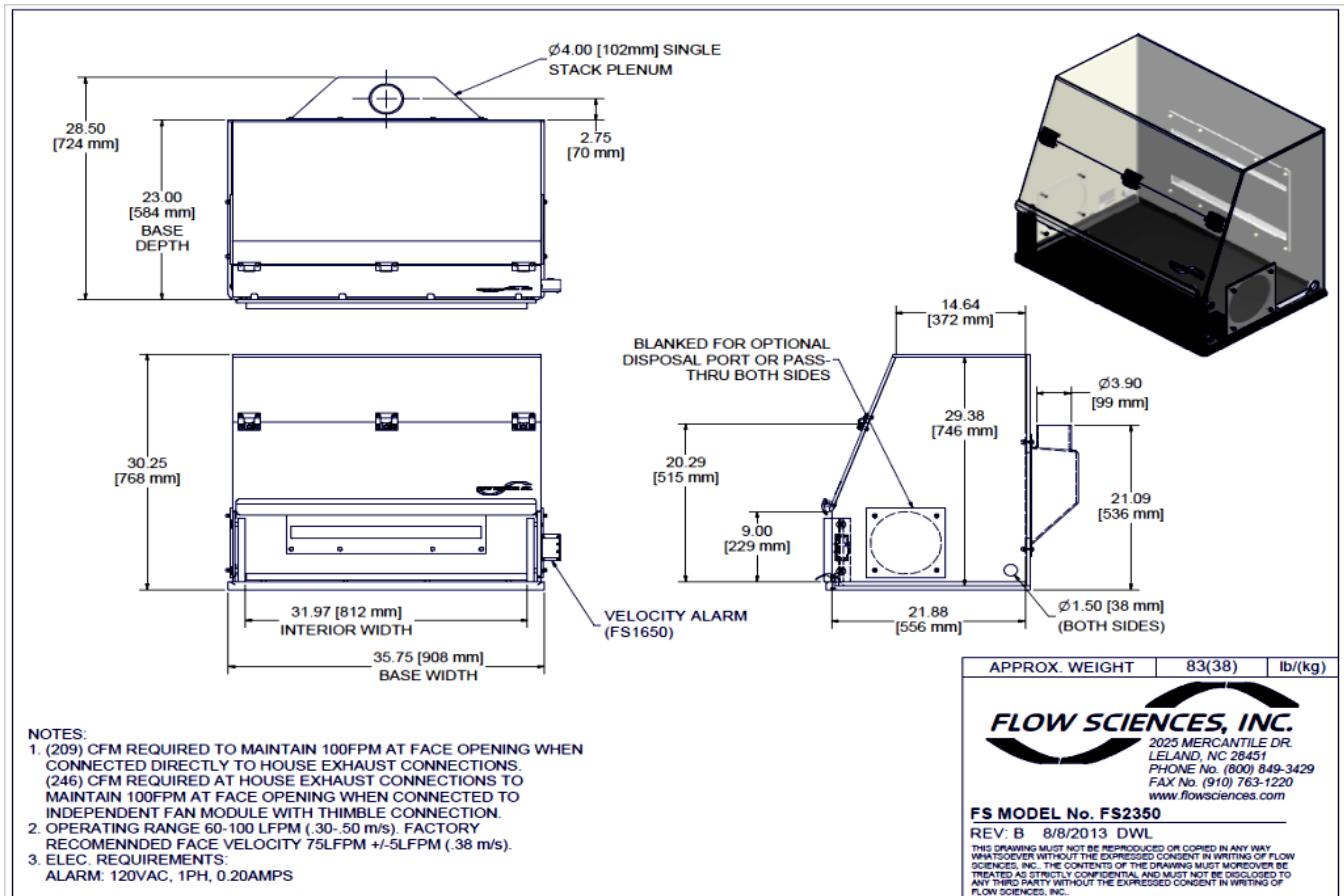

END OF SECTION